

UFO LED High Bay Light



Model	Power	Lumens	Input Voltage	CRI	Power Factor	LED chip	Beam Angle	IP Rate
YS-UFO100	100W	12500-14000Lm	AC100-277V	80	>0.95	LUMILEDS	60°/90°/120°	65
YS-UFO150	150W	18750-21000Lm	AC100-277V	80	>0.95	LUMILEDS	60°/90°/120°	65
YS-UFO200	200W	25000-28000Lm	AC100-277V	80	>0.95	LUMILEDS	60°/90°/120°	65
YS-UFO240	240W	30000-36000Lm	AC100-277V	80	>0.95	LUMILEDS	60°/90°/120°	65
YS-UFO300	300W	37500-42000Lm	AC100-277V	80	>0.95	LUMILEDS	60°/90°/120°	65

*Note:CCT: Natural white:4000K Day white: 5000K; Cool white: 5700K / 6500K;

Features

- Black /White die casting aluminum(6063 aluminum) housing, Excellent Thermal Management;
- Super bright: As high as 135Lm/W lumens efficiency; the best energy saving; with Philips Lumileds 3030 LED, Ra80,
- Yunsun self-designed or Meanwell External UL CE TUV driver, 5 years warranty,
- IP65 waterproof for indoor / outdoor application
- No UV or IR in the beam
- Easy to install and operate
- NO flickering, NO humming



Special Design For Warehouse

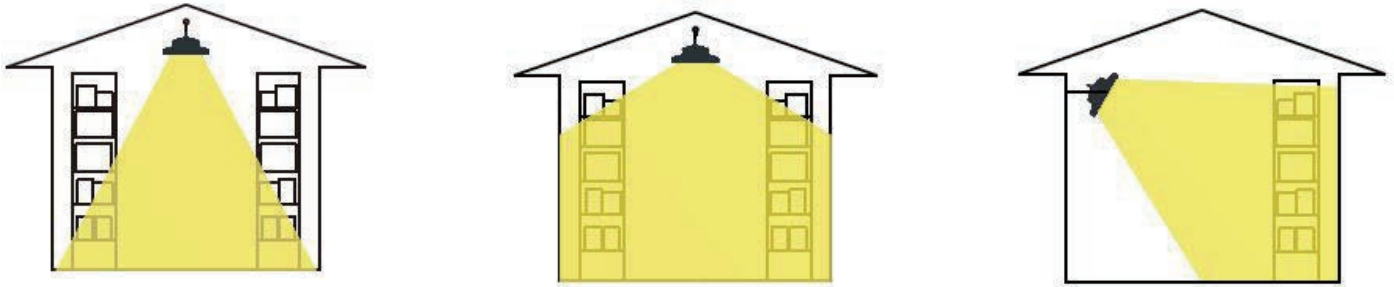

60/90/120 beam angle Options. Can application to all kinds of factories, warehouses, Supermarket, exhibition hall, Stadiums and so on.

Size & Packaging

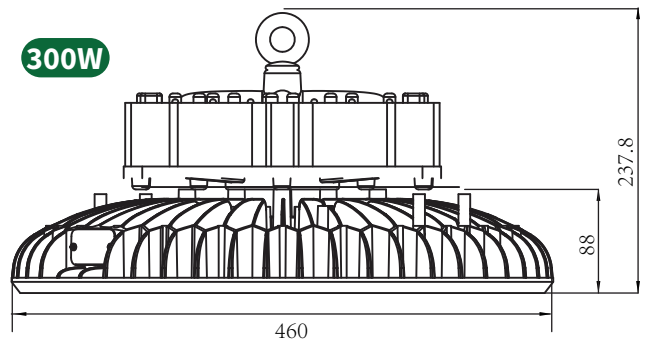
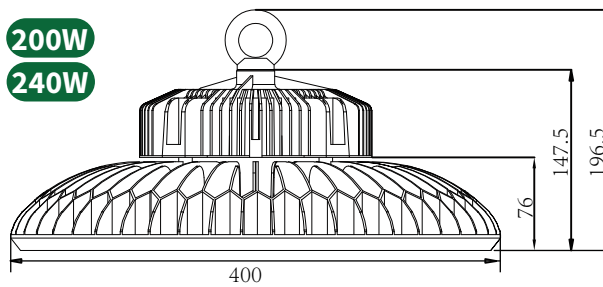
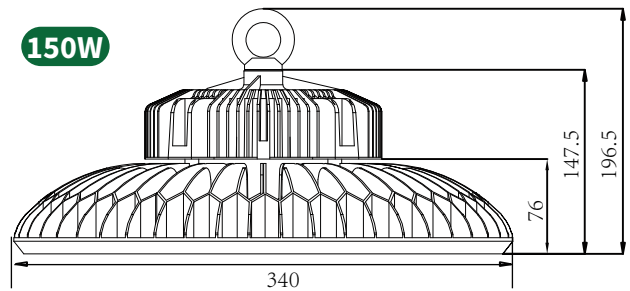
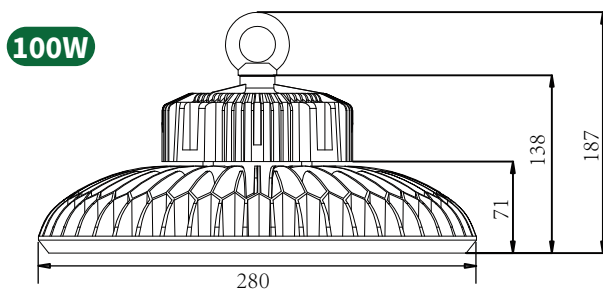

Packing	Model	Size	Gross Weight	Model	Size	Gross Weight
	100W	330*330*190mm	4.2Kg	240W	445*445*200mm	8.0Kg
	150W	390*390*200mm	5.6Kg	300W	525*525*260mm	13Kg
	200W	445*445*200mm	8.0Kg			

Installation

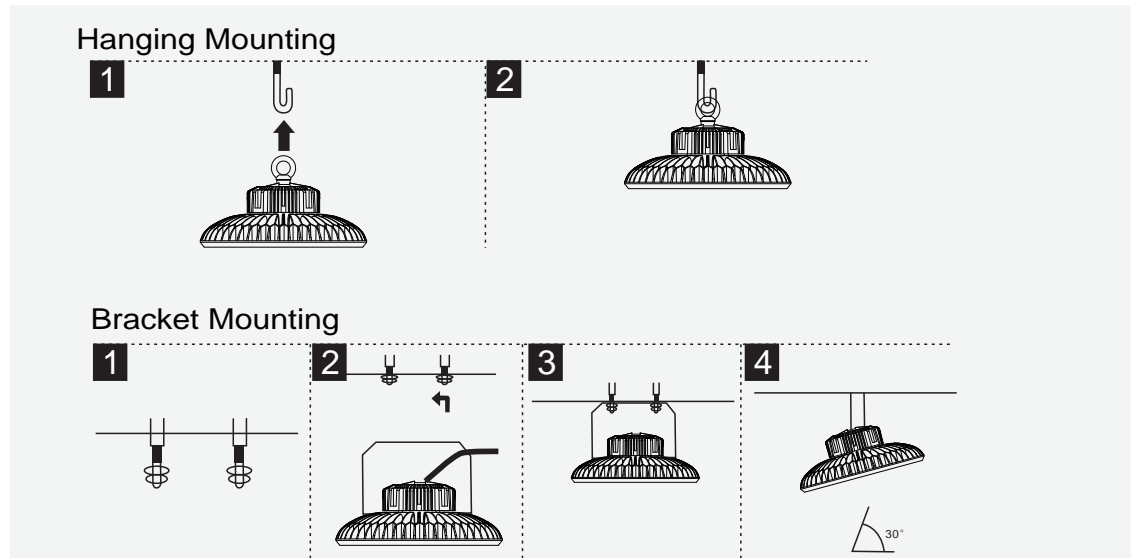

LUMILEDS LED

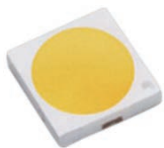

Ra>80
50000Hours

LUMILEDS 3030 Chip
Options,Ra>80;80Lm Standard,High luminous
Efficiency,long Life, Cost-Effective.

Model	100W	150W	200W	240W	300W
LED (pcs)	133	210	266	315	483

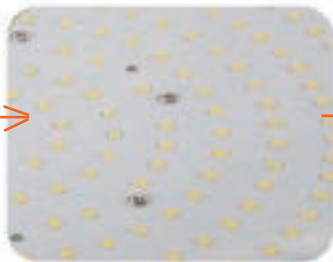
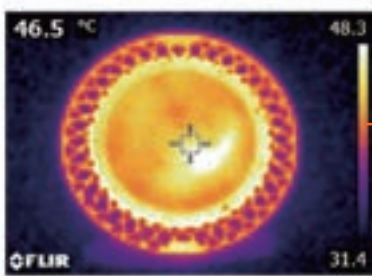

3030SMD LEDs
Low Thermal Resistance
Every Chips have enough
space,the temperature
will be lower.

Good Cooling Will Keep Longer Lifespan



6063 Alumin fins
heatsink and wide
aluminum PCB,
larger heat
dissipation area